

Article number: 435700017

Description: Rota-fix shaft-hub connection K 17x35

Note: Self centering. Medium torque

## Measures

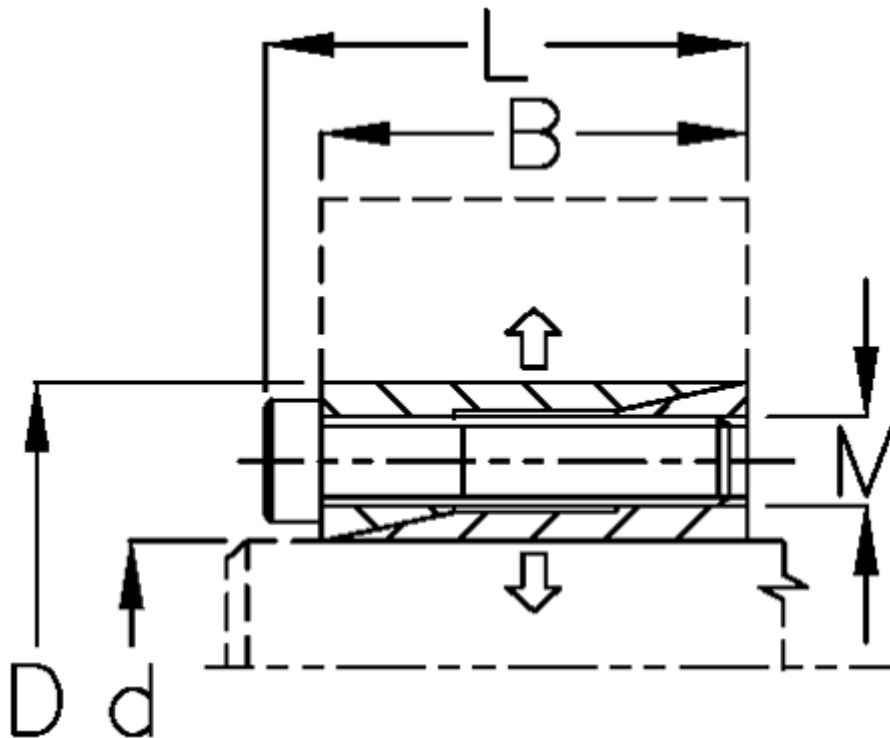

B mm	= 21
d mm	= 17.00
D mm	= 35
Fit tolerance	= Aksel h8, Nav H8
F kN torque	= 8.0
L mm	= 25.0
M mm	= M4
P N/mm <sup>2</sup> surface pressure on shaft/hub	= 60

Surface roughness	= R? ? 3.2 $\mu$ m
T N m torque	= 75
Ts N m bolt tightening torque	= 4.9